

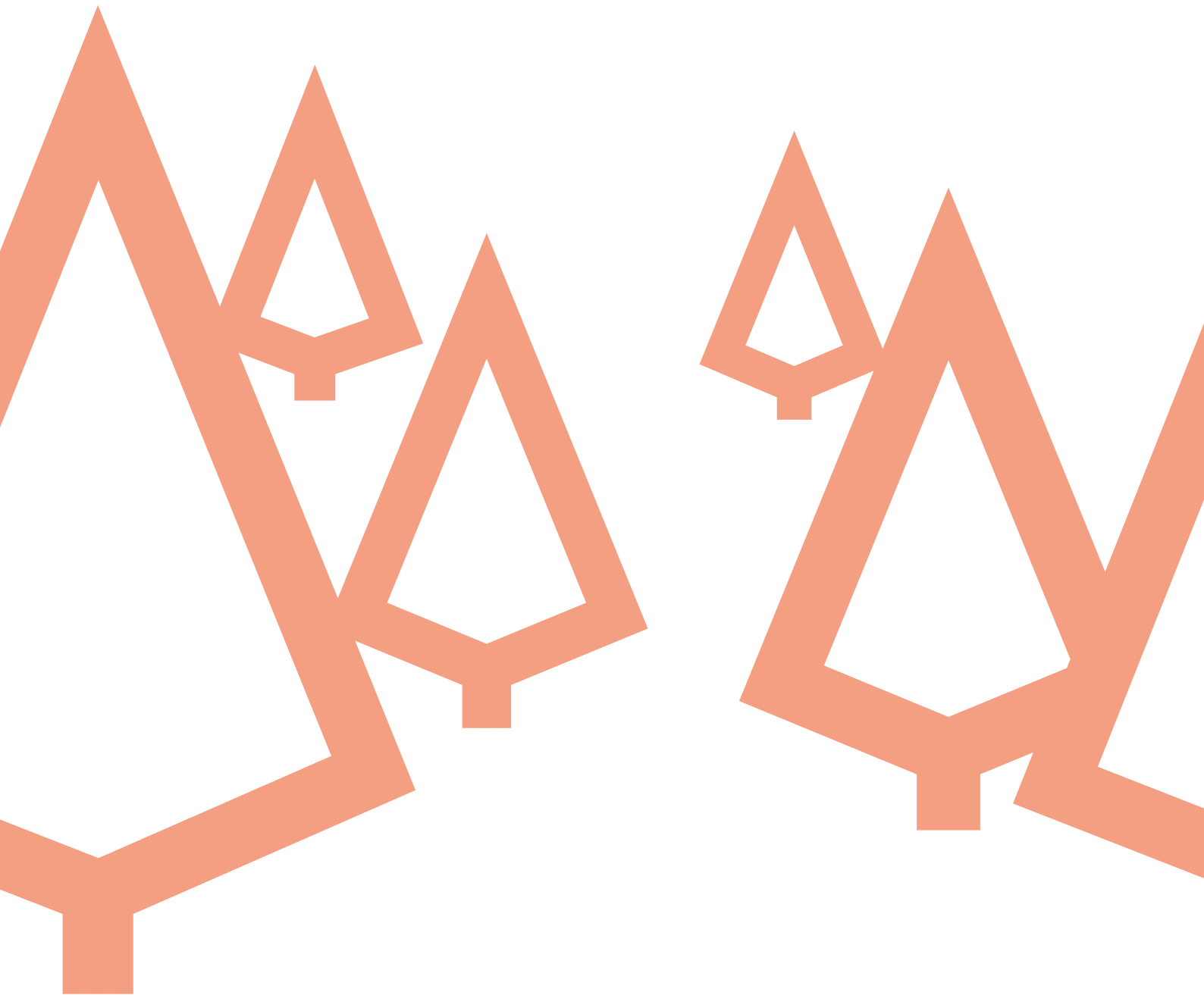

LUNAWOOD

DECKING INSTALLATION GUIDE
WITH PROFIX 2 PLUS HIDDEN FIXING SYSTEM



WWW.LUNAWOOD.COM

Decking Installation Guide

Please check and read carefully legal disclaimer and written instructions after the picture guidelines.

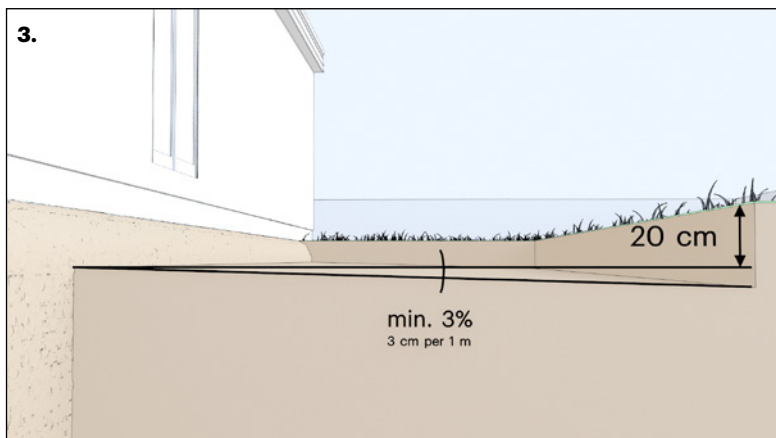
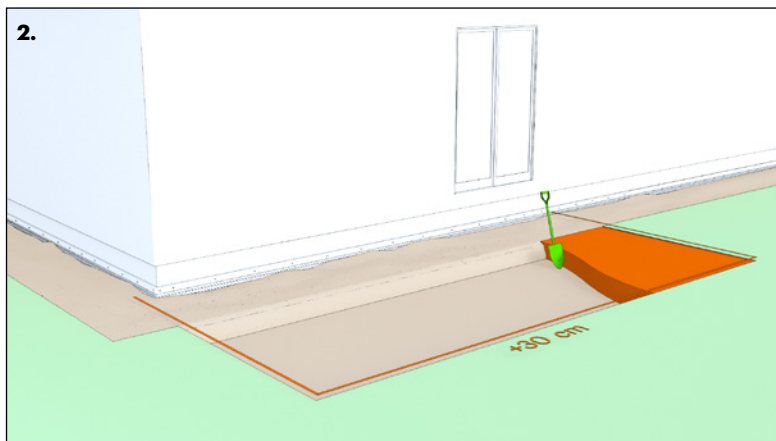
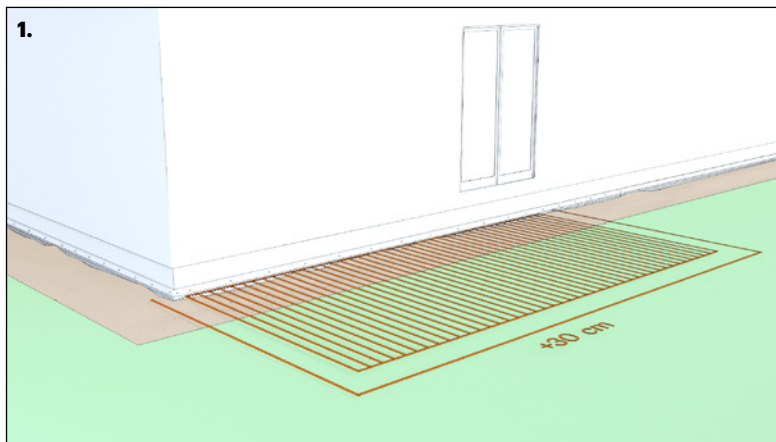

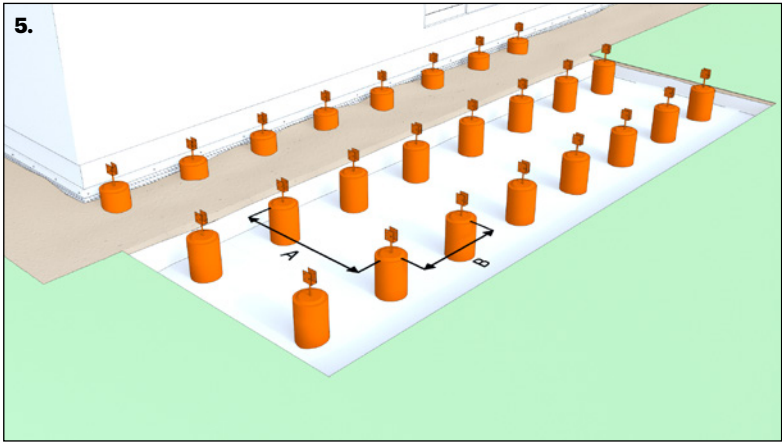
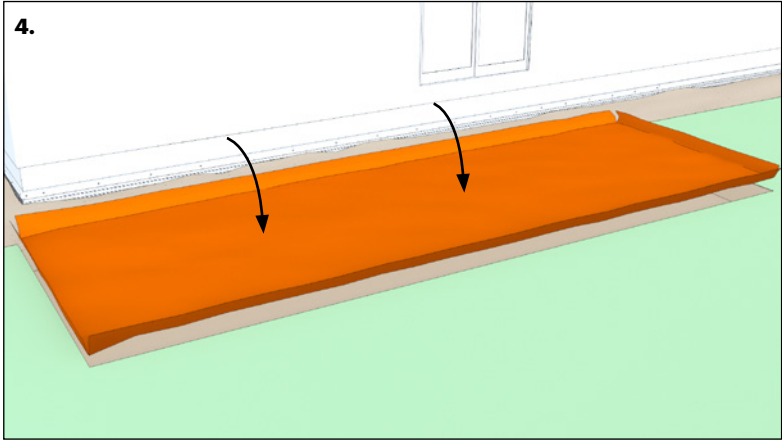

A	max. 120 cm – 140 width support
B	max. 80 cm – 92 width support

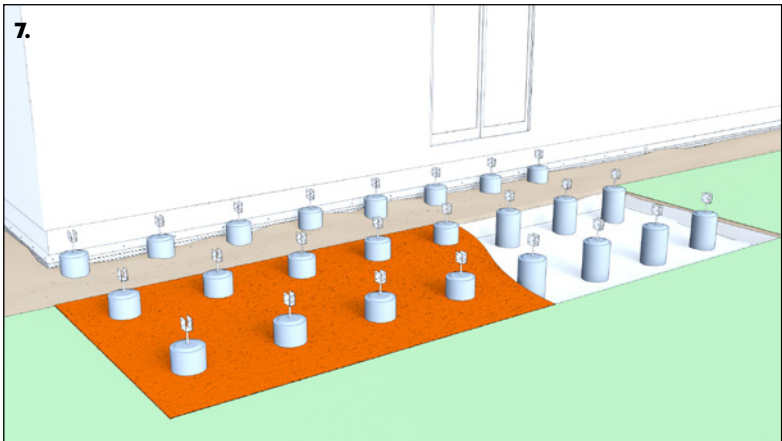
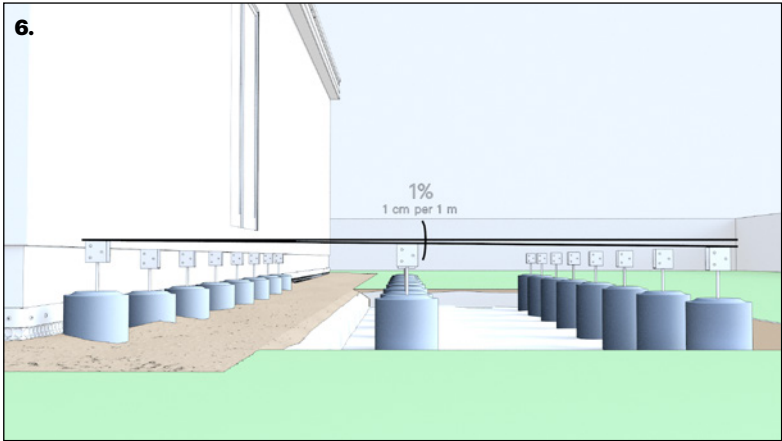

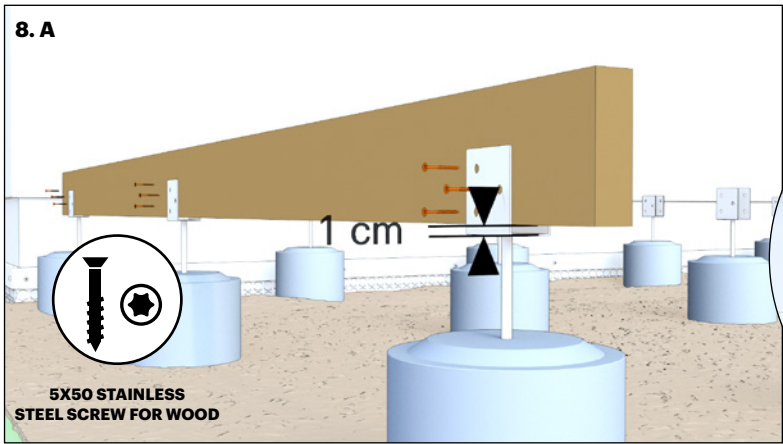
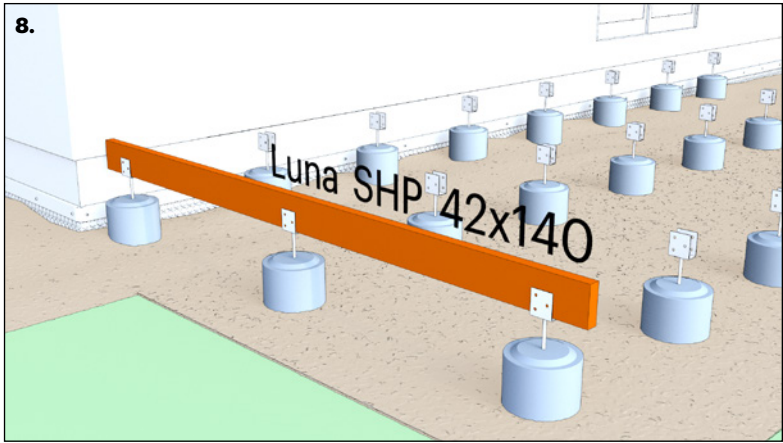

Option A

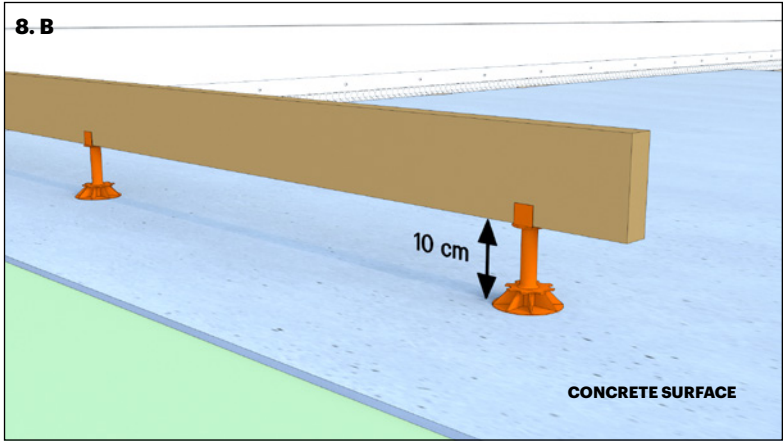
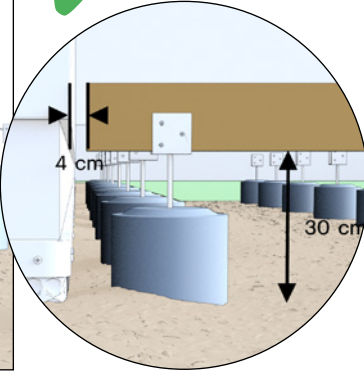

Option B

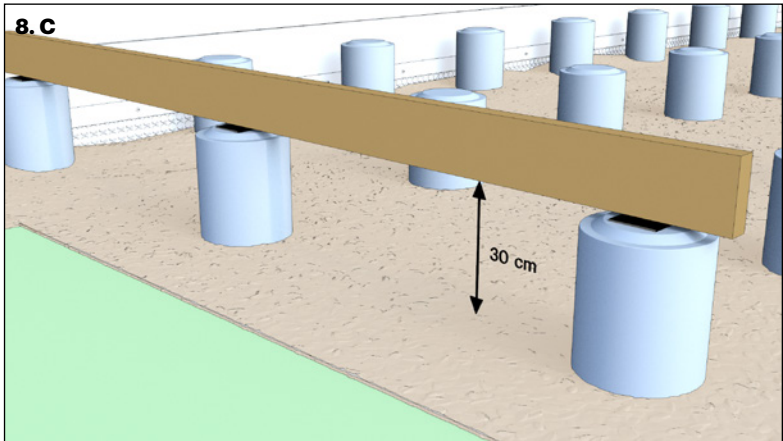

Option C



Bitum layer to block moisture to rise from the ground to the timber structure.

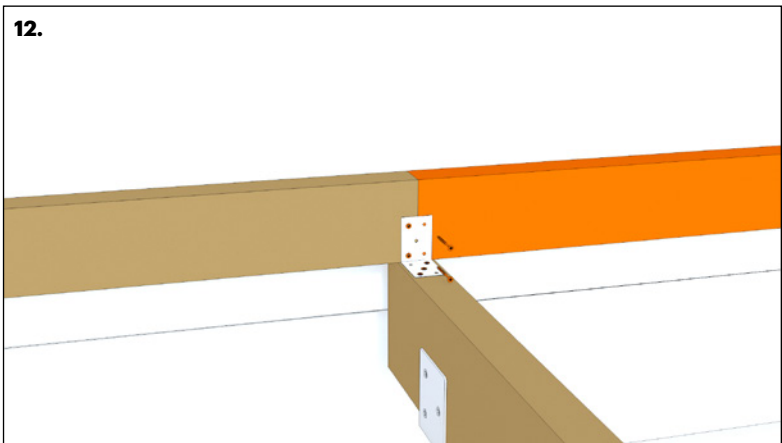
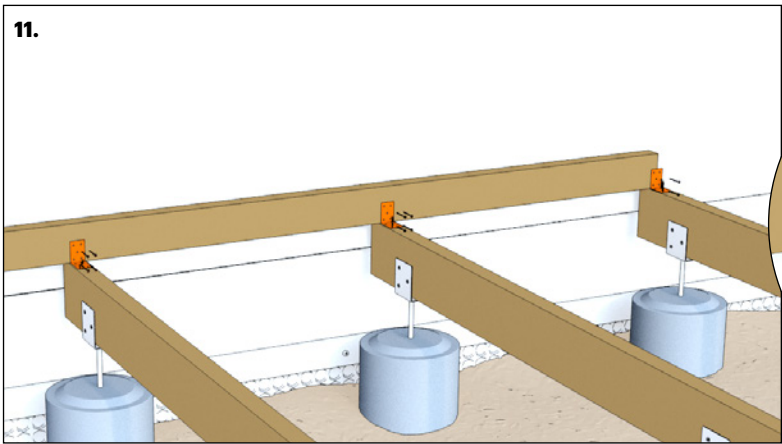
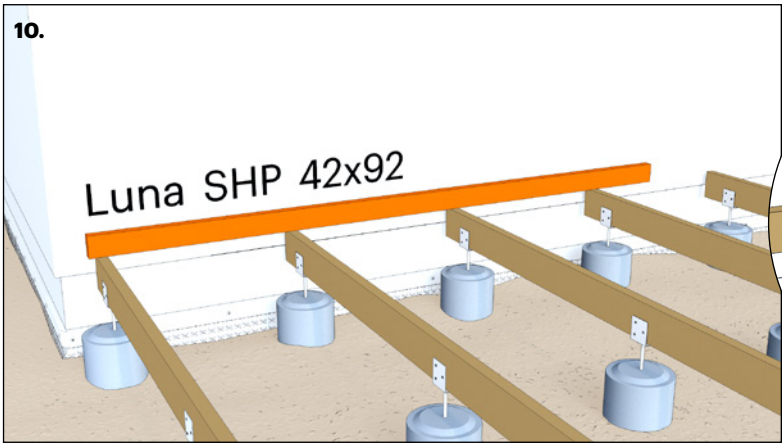
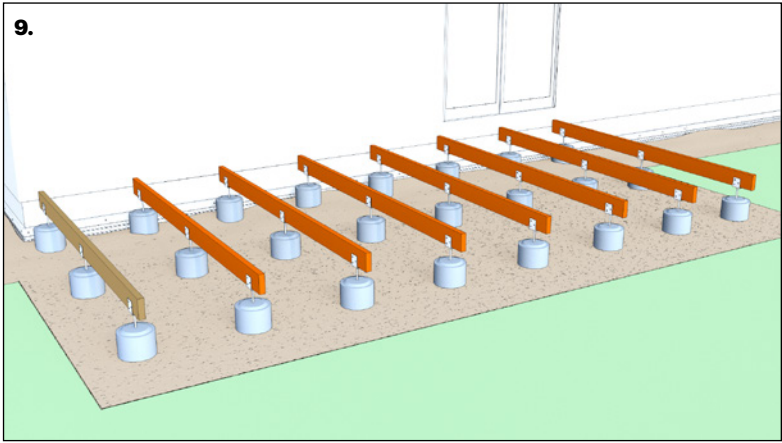

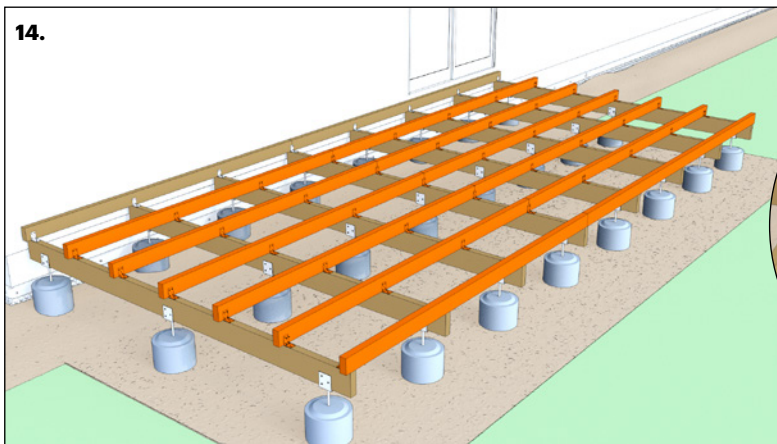
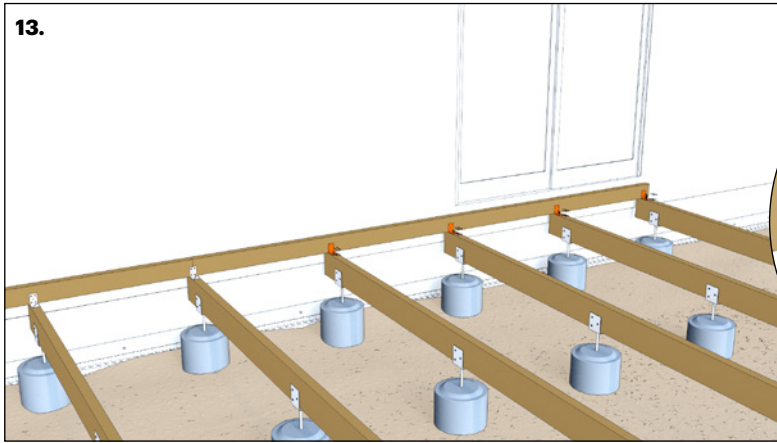

Deck Board

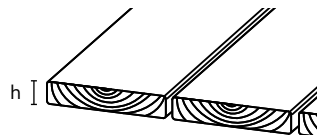

	h = 26 mm	h = 40 mm
A	max. 45 cm	max. 60 cm

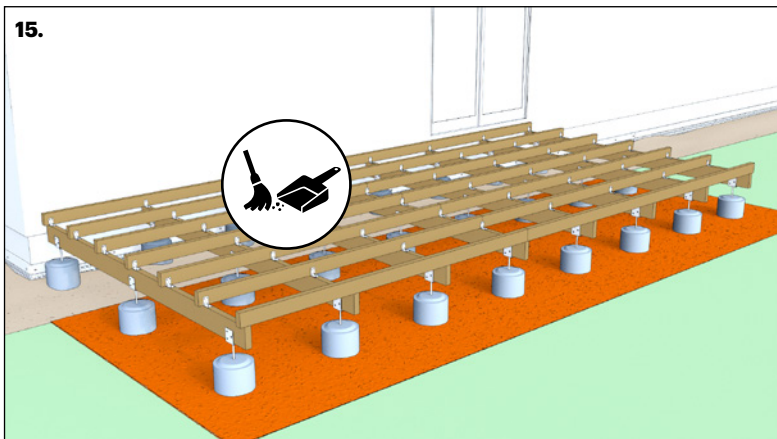

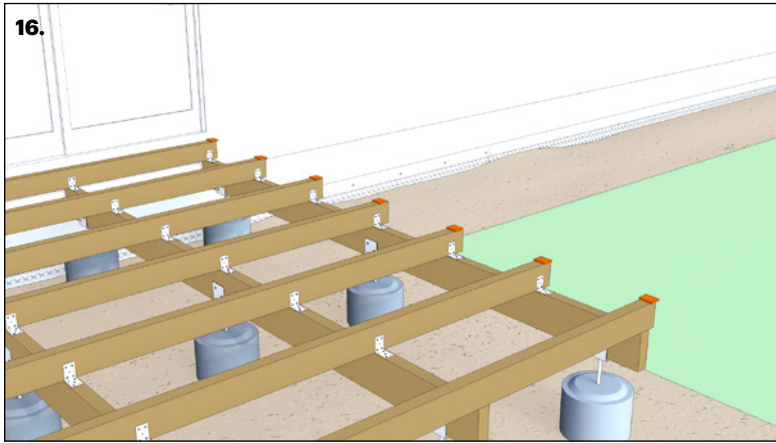

Bitum layer (40 x 50 x 7 mm) to block moisture to rise from the ground to the decking.

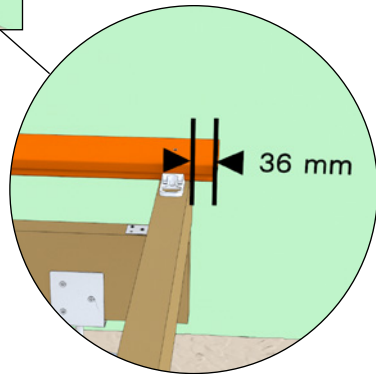
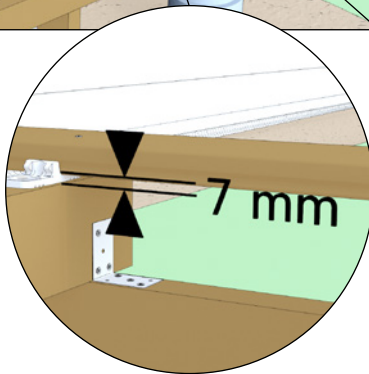
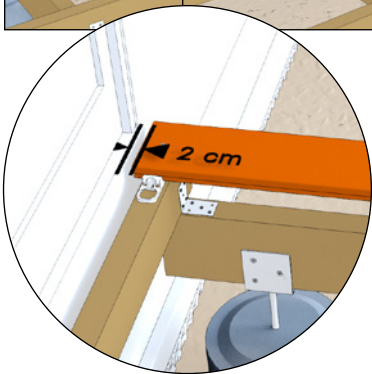
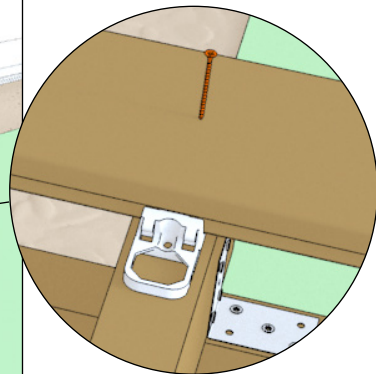
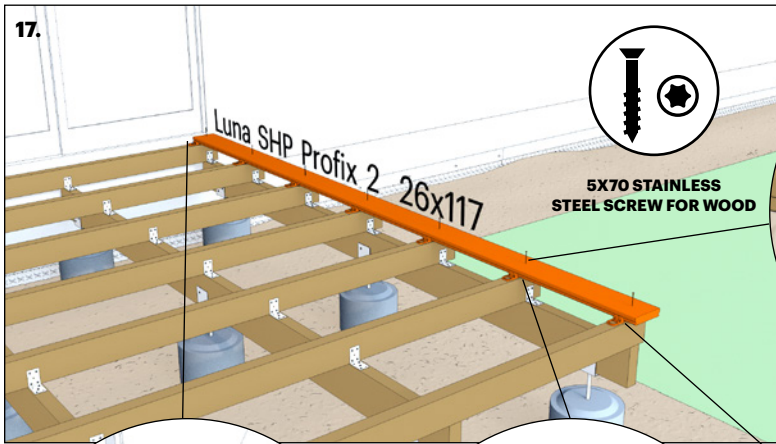

Large terrace (> 5 m)

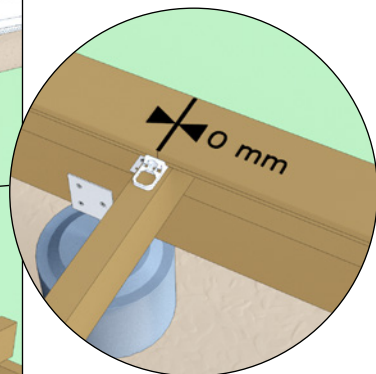
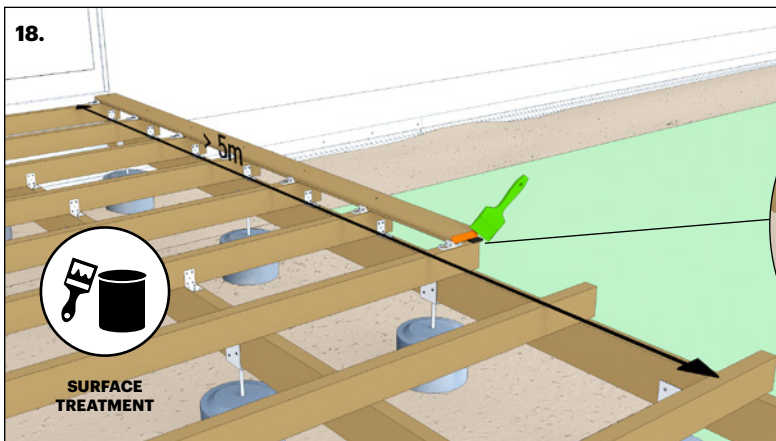

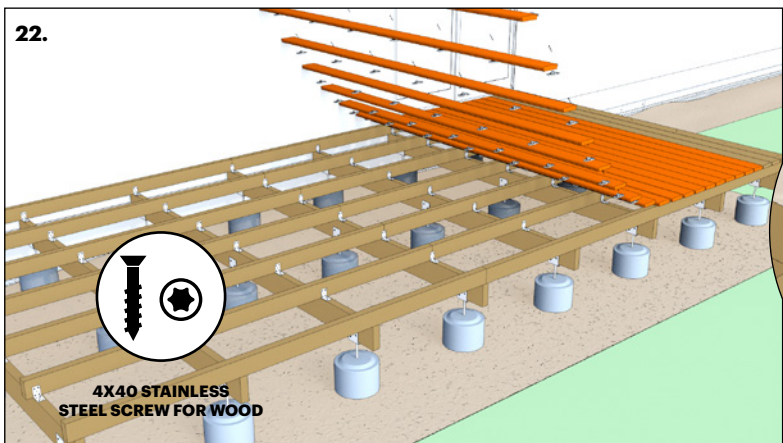
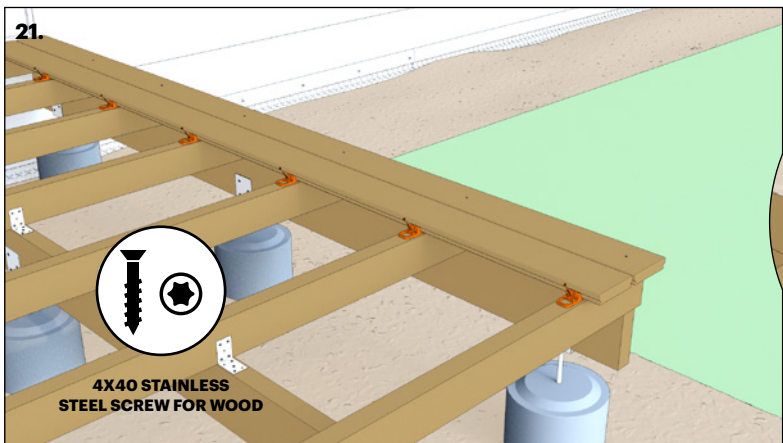
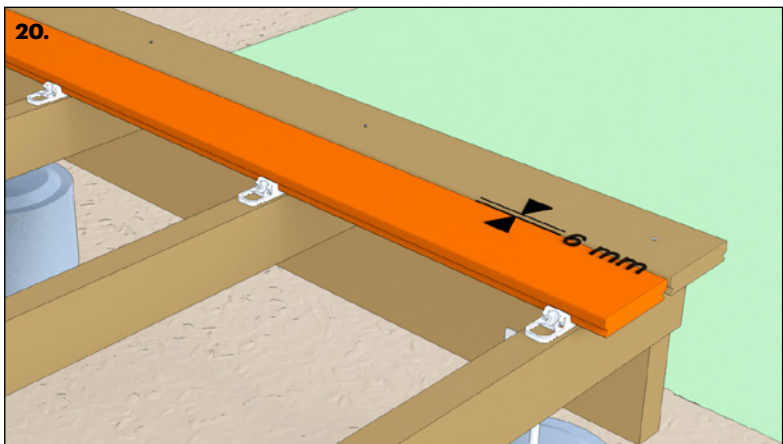
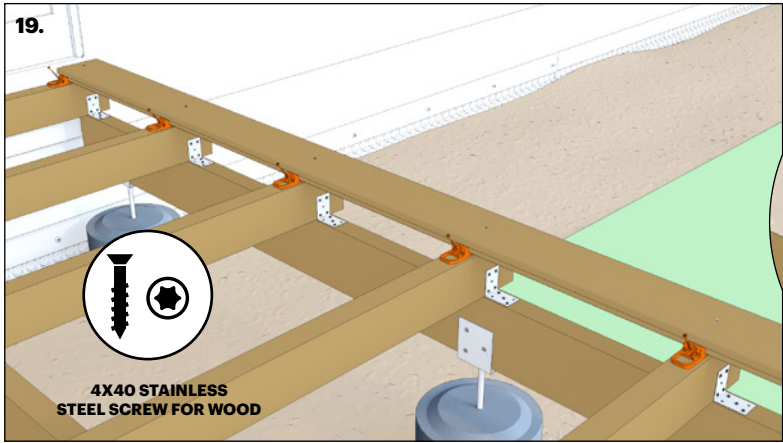

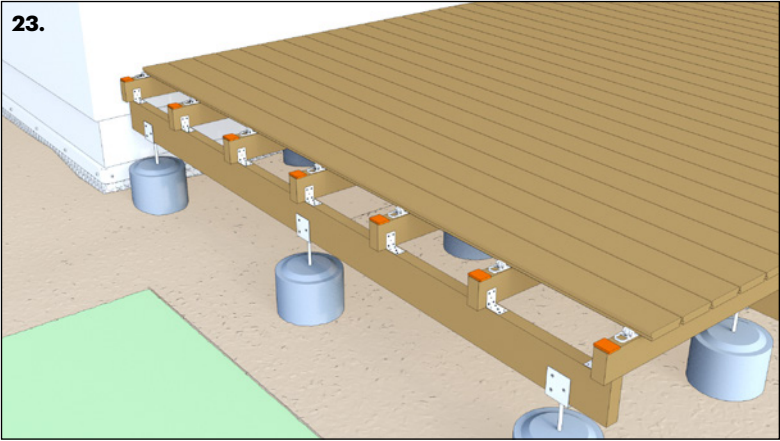

Bitum layer (40 x 50 x 7 mm) to block moisture to rise from the ground to the decking.

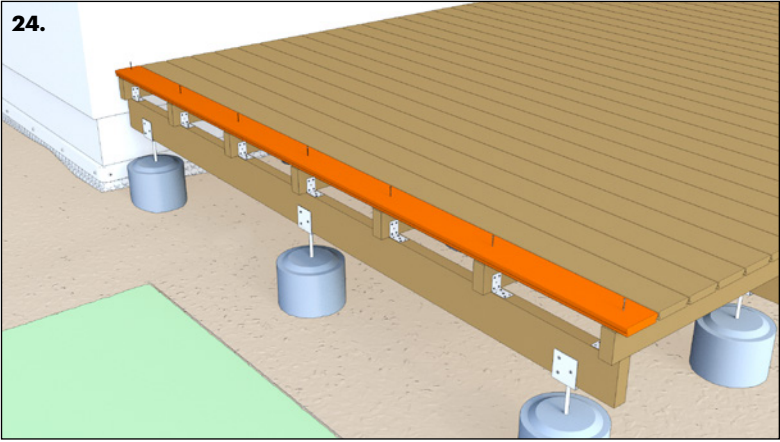

5X70 STAINLESS
STEEL SCREW FOR WOOD

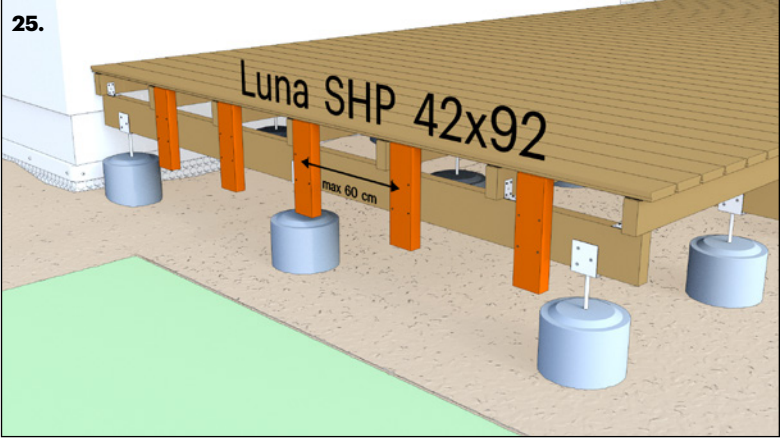

5X70 STAINLESS
STEEL SCREW FOR WOOD

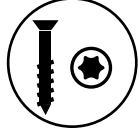
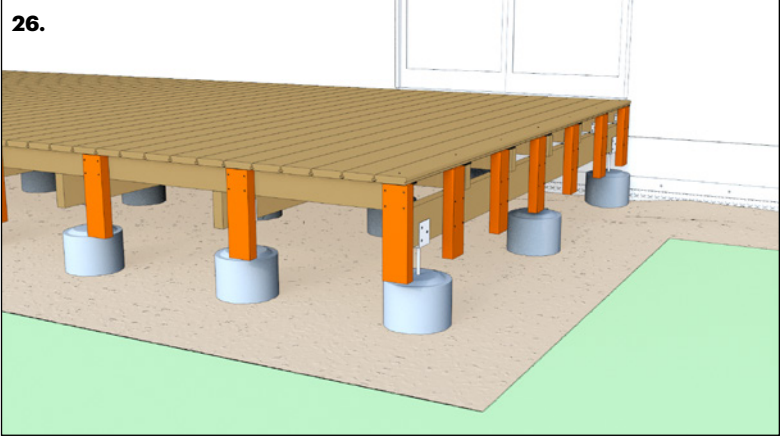

5X70 STAINLESS
STEEL SCREW FOR WOOD

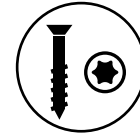
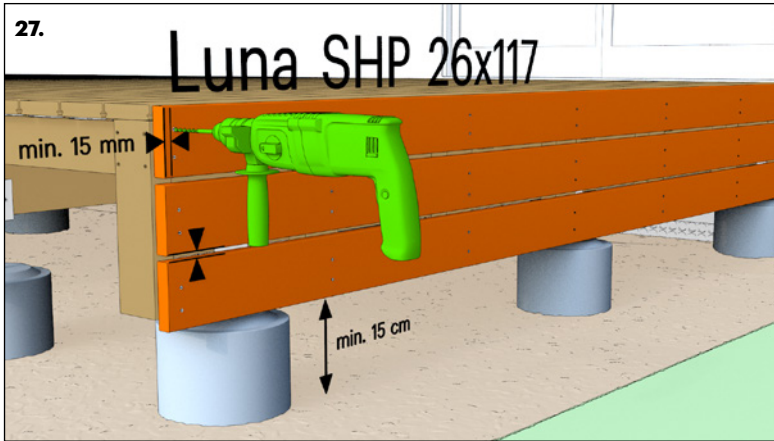

**5X70 STAINLESS
STEEL SCREW FOR WOOD**

Predrill first to avoid deck board to crack in the end of the board.

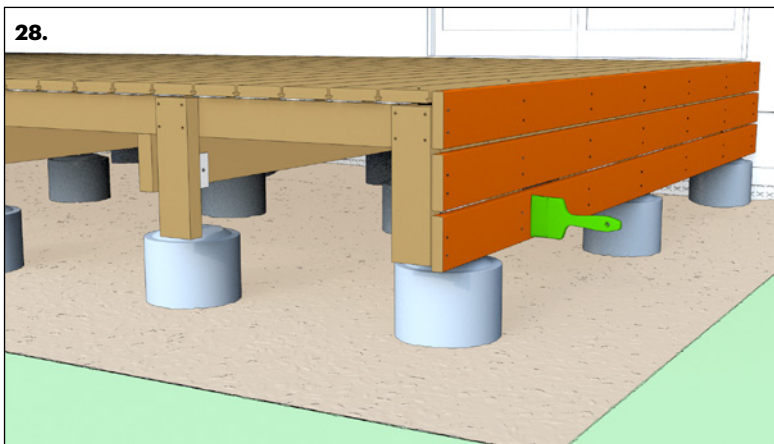

**SURFACE
TREATMENT**

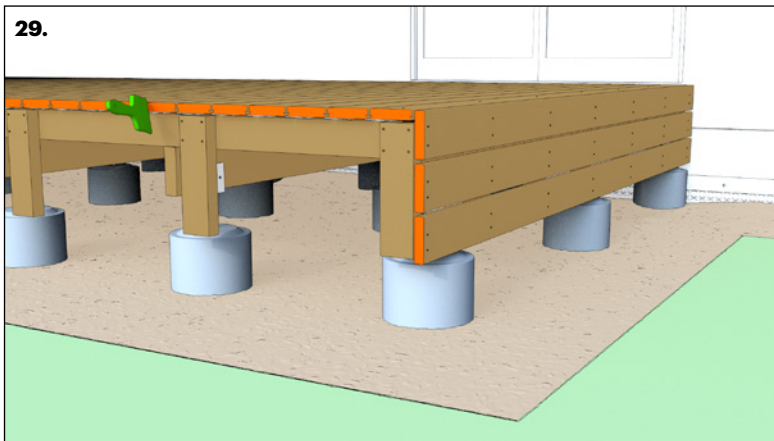

**SURFACE
TREATMENT**

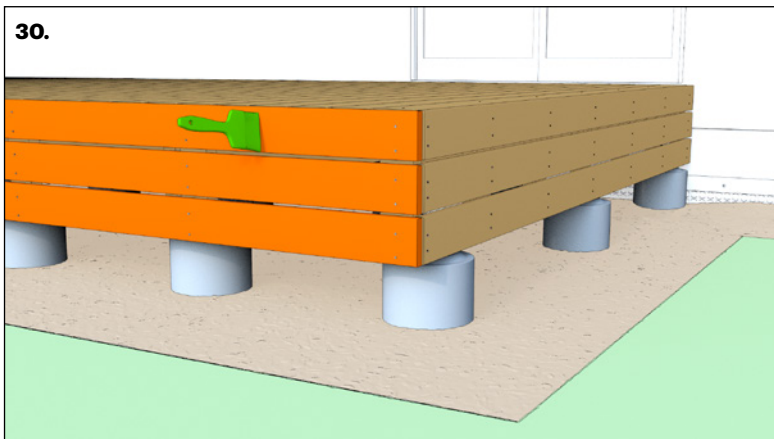

**SURFACE
TREATMENT**

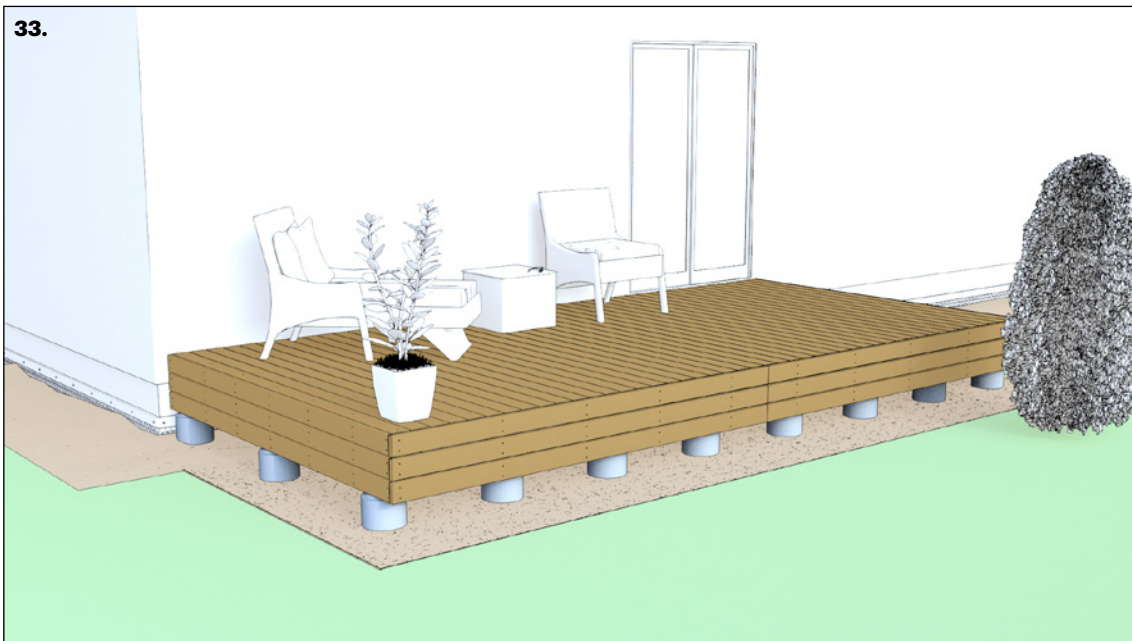
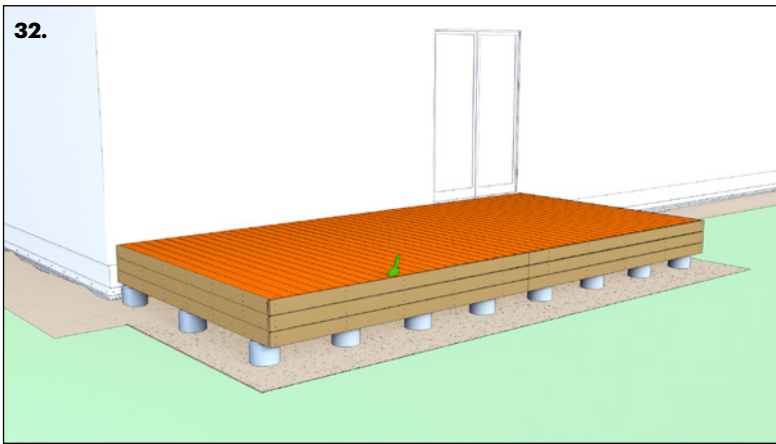
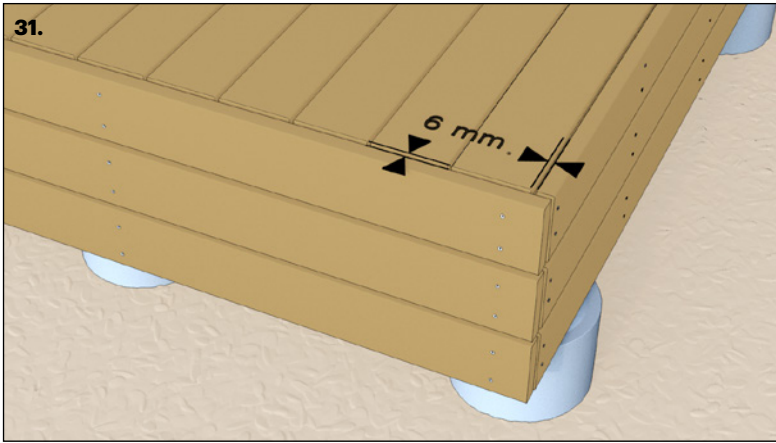

LEGAL DISCLAIMER – Lunawood Decking

BEFORE INSTALLATION

For best results, Lunawood decking should be protected from direct sunlight and weather before installation by covering the material and keeping it off of the ground.

Stainless steel screws are required to properly fasten Lunawood decking in order to have longer lifetime and no appearance of rust – if the board is installed through the face, two screws per joist. The only hidden fastener accepted for use is the Lunawood Profix – system (suggested). When screwing through the face, a Standard miter and table saws with carbide-tipped, sharp blades are appropriate to use.

This guide and the animation of building Lunawood deck in Lunawood.com - is to promote water shedding and the ease of drying (continuous, efficient ventilation around the deck boards and deck area).

- Minimum thickness of the deck boards for decking is 26mm (Scandinavian Pine). The heart side of the board should be laid uppermost. Heart side is use side. (Luna Thermo D, Scandinavian Pine)
- The under structure or sub frame should be made from suitable material with the necessary durability and design so as not to adversely affect the performance of the deck board.
- Lunawood materials may not be in direct contact with the ground or in a permanently wetted situation. The construction should not create conditions that can later be considered as direct contact with ground i.e.
 - Space beneath the deck is not sufficient enough to allow air circulate and allow wetted ground to dry.
 - The humid air that drying ground releases is trapped beneath the deck e.g.the space beneath the deck area is concealed with structures or boards
- The contact surface between joists and deck boards should be as minimal as possible.
- If the terrace is next to a building the drop should be designed so that water runs away from the building and decking boards should be laid in the same direction.
- Avoid water entrapment under planters, sand pits, paddling pools or similar objects. These items should be moved or rotated regularly to avoid permanently wetting an area of the deck
- Ensure regular brushing and cleaning of the deck to remove dirt from between the boards and from the top of the surface. Obstacles such as leaves, needles and other outdoor materials will restrict water shedding and allow water trapping
- Fixing material should be with Stainless Steel screws through pre-drilled holes especially close to the ends of the boards to avoid end cracking.
- There should be a minimum 6mm gap between boards for dimensions 92 mm- 140mm widths and between the boards and wall to allow for water drainage.

INSTALLATION

Lunawood suggests that the boards are end-sealed after cutting with a clear, water resistant surface treatment. If end sealer is not used, the manufacturer has possibility to reject any claims under expected life cycle. To further protect Lunawood decking, we require it to be finished with minimum water based surface treatment prior or after to installation. Please consult local paint manufacturer for the right surface treatment for your Lunawood deck.

Our decking products are carefully manufactured and inspected to ensure quality. However, these are natural wood products and are subject to variations in weight, density, color, grain. Wood decking is naturally subject to dimensional changes as the moisture content in the wood fluctuates with humidity in the air. Swelling, shrinkage, surface checking, and other movement of individual pieces are normal occurrences in wood decking. Nevertheless, with Lunawood decking the swelling and shrinkage are minimal compared to untreated Scandinavian Pine and Spruce.

Local building codes must be consulted when building an exterior deck. Most countries may require building permits. Please also see the animation of Lunawood decking in www.lunawood.com and PDF guide in www.lunawood.com too.

Safety glasses and a dust mask should always be worn when working with Lunawood timber. We recommend an active carbon filter dust mask. Avoid splinters to hands and use gloves when installing. Drilling, Sawing, sanding or machining wood products generates wood dust. Avoid inhaling wood dust or use a dust mask or other safeguards for personal protection.

Drawings and schematics used to show where to place screws and nails are for reference purposes only.

Decking must be built in accordance with regulatory requirements. Should the intended walking traffic requires it, the number of battens (or joists) for a decking project may be increased from the recommended in Lunawood Installation animation or PDF guide in www.lunawood.com.

MAINTENANCE

Every exterior surface made from timber, needs regular maintenance. This means in practise; cleaning the surfaces with mold removal liquids and right amount of water. Use brush of similar. Avoid harming the actual surface of the exterior decking or face or other end use when cleaning. Consult your local professionals in exterior surface treatment installations or manufacturers. If exterior surfaces are not maintained regularly there will be surface mould, dirt, dust, soil, leaves, air impurities building up to the surfaces which will shorten lifetime of the exterior timber surface drastically. Take care of the surface treatment in regular basis to protect the wooden surface for having longer lifetime for Lunawood Exterior Claddings or Deckings.

OTHER INFORMATION

Every deck is different and this guide nor animation by Lunawood in www.lunawood.com should not be considered to set out how a deck should be constructed in every circumstance. We accept no liability for any loss or injury caused by any reliance placed on this guide. Lunawood reserves the right to update or revise the Terms and Conditions regarding installation guides in www.lunawood.com.

The entire content of the Site is protected by copyright. You may not copy, distribute, or create derivative works from any part of this Web site (including its graphics, pictorial matter, and text) without the prior written consent of Oy Lunawood Ltd unless otherwise expressly permitted by the Site.

Lunawood®; Lunawood TWPC and Lunawood Thermowood Plastic Composite, Profix are trademarks, service marks or trade names of Oy Lunawood Ltd and may not be used without prior written permission.

Any links on this document or Lunawood.com to third party Web sites are not an endorsement, sponsorship, or recommendation of the third parties or the third parties' ideas, products, or services. Similarly, any references in this Site or document to third parties and their products or services do not constitute an endorsement, sponsorship, or recommendation. If you follow links to third party Web sites, including the Web sites of any other companies affiliated or unaffiliated with Lunawood, you are subject to the terms and conditions and privacy policies of those sites, and Lunawood makes no warranty or representations regarding those sites. Further, Lunawood is not responsible for the content of third party or affiliated company sites or any actions, inactions, results, or damages caused by visiting those sites.

DISCLAIMER OF WARRANTIES

THE MATERIAL IN THIS WEB SITE OR IN THIS DOCUMENT IS PROVIDED "AS IS," WITHOUT ANY KIND OF WARRANTY. THE MATERIAL ON THIS WEB SITE IS NOT A WARRANTY AS TO ANY PRODUCT OR SERVICE PROVIDED BY OY LUNAWOOD LTD OR ANY SUBSIDIARIES.

LIMITATION OF LIABILITY

OY LUNAWOOD LTD IS NOT LIABLE FOR ANY ERRORS, DELAYS, INACCURACIES, OR OMISSIONS IN THIS SITE OR ANY SITES THAT ARE LINKED TO, OR REFERRED TO BY, THIS SITE. UNDER NO CIRCUMSTANCES SHALL OY LUNAWOOD LTD BE LIABLE FOR ANY DAMAGES, INCLUDING INDIRECT, INCIDENTAL, SPECIAL, OR CONSEQUENTIAL DAMAGES THAT RESULT FROM THE USE OF, OR INABILITY TO USE, THIS SITE WHETHER BASED ON ACTIONS IN CONTRACT, TORT, NEGLIGENCE, STRICT LIABILITY, OR OTHERWISE, EVEN IF OY LUNAWOOD LTD HAS BEEN ADVISED OF THE POSSIBILITY OF SUCH DAMAGE.

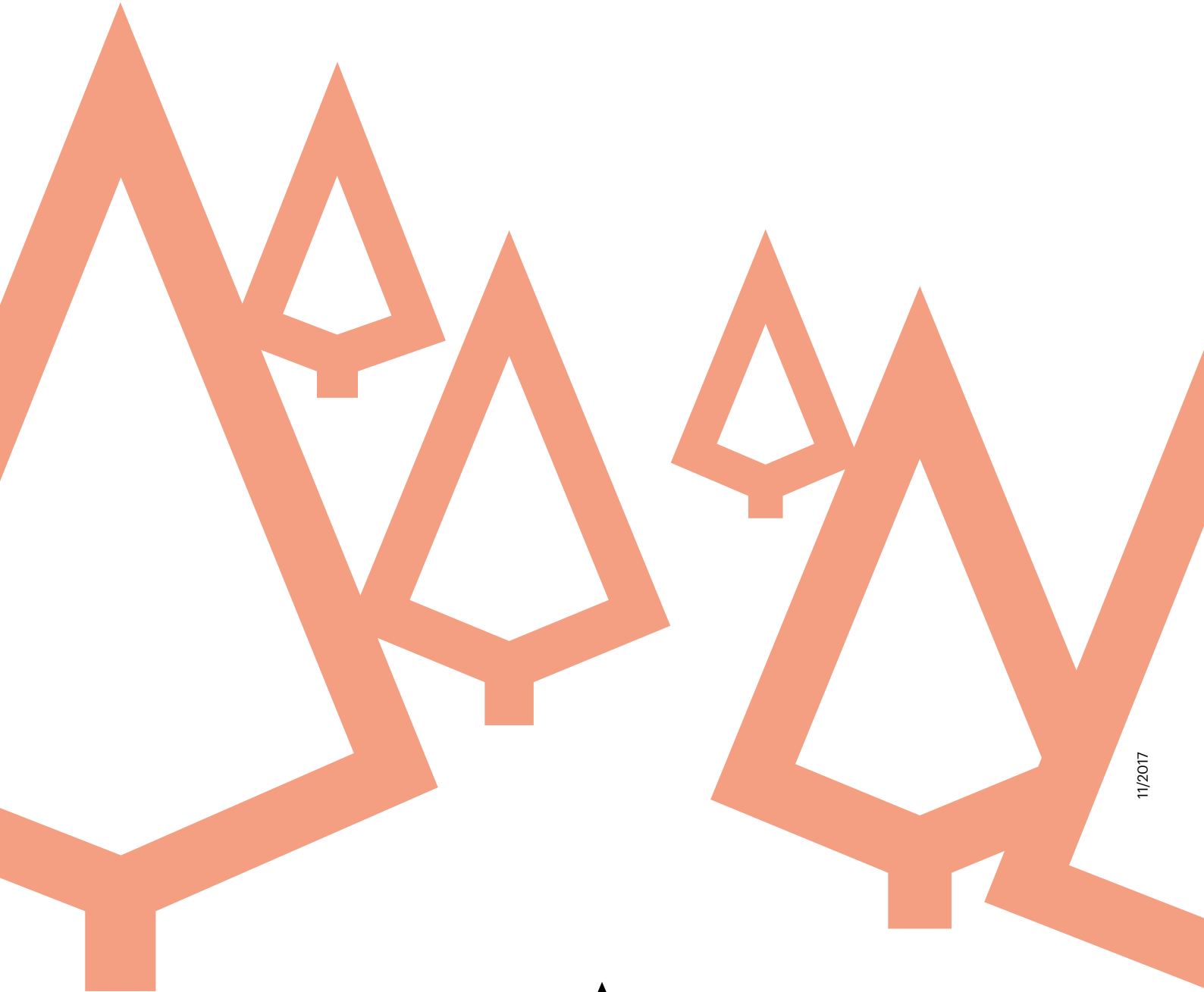

11/2017



WWW.LUNAWOOD.COM